

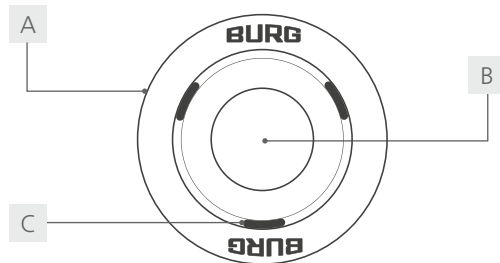

Corona
Operating Manual

Corona

Knob



- A Silicone ring
- B RFID sensor / antenna
- C Status LED

Back unit

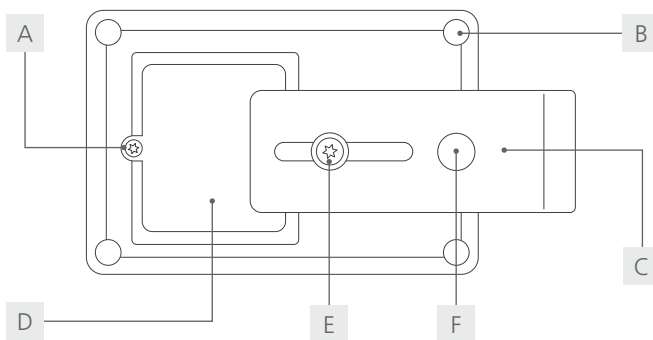

- A Fixing screw
- B Mounting hole
- C Latch
- D Battery compartment cover
- E Latch adjustment screw
- F Knob fixing screw

Content

Introduction.....	2
General.....	2
Technical data.....	3
Default settings.....	3

Scope of delivery.....	3
Scope of features.....	4
Dimensions.....	4
Mounting hole dimensions.....	4
Functional description.....	5 - 6
LED and tone signals.....	7
Assembly instructions.....	8
Configuration.....	9
Operation.....	9
Reset on default setting.....	10
Battery replacement.....	10
Disposal and battery note.....	10

Introduction

Dear Customer,

Thank you for choosing the **Corona** - the electronic RFID locking system that allows lockers or safes to be locked in a secure and comfortable manner.

Thank to its variable adjustability, the Corona is very easy to retrofit in existing situations. The solid design of the Corona's bolt and housing ensures an unprecedented level of security: Thank to its zamak components, the lock can easily withstand a force of at least 800 N. The Corona is suitable for installation in wooden and metal doors and flexibly covers different door thicknesses.

Important: Please note all warnings and read through the entire operating manual before you begin configuration.

We hope you enjoy using your new locking system.

Your BURG-Team

General

The latest version of this guide is always available at: www.burg.de

Factsheet

Knob



Back unit



Technical Data	
Dimensions	Knob: Ø 41 mm Back unit: 98 x 66 x 40 mm
Batteries	CR123A lithium battery 3V (2x)
Locking cycles	Corona II: approx. 45,000 Corona II B-on-air: approx. 25,000 Corona I: approx. 30,000
Working temperature	0° C to 55° C rel. humidity: 96%
Mode	Multi User Mode, Private Mode
Material	Knob: plastic / silicone Back unit: zamak
Latch	Zinc
Locking direction	L, R
Lock attachment	Wood: screws Metal: M19 nut
Door thickness	Wood: 16, 19, 22 mm Metal: max. 3,5 mm
RFID types	125 kHz: T5577; EM4102 Corona I (not changeable): MIFARE® Classic; HITAG S/ 1 Corona II (changeable): MIFARE® Classic and Desfire; HID iClass (read only); Ultralight; Legic Advant (read only); NTFAG
RFID reading distance	5 to 10 mm
Master cards	max. 3
Transponder	125 kHz (T5577): max. 50 Corona I / Corona II: max. 40

Default Settings	
Mode	Multi User Mode
LED locking indications	On
Signal tones	On
Locking/ Unlocking	manually
Area restriction ^{1,2}	-
Locker numbers ^{1,2}	deleted (=0)
Closure duration ²	Off
Room information ²	Off

Scope of Delivery	
<ul style="list-style-type: none"> ▪ 1x locking system (Knob and back unit) ▪ 1x battery compartment cover (incl. screw) ▪ 1x fixing material (incl. screws) ▪ 2x battery (CR123A)³ 	

Features	
<ul style="list-style-type: none"> ▪ can be used in wooden and metal doors (indoor) ▪ latch system - door locks when pushed ▪ integrated LED locking indication ▪ high-quality and stable workmanship (metal housing) ▪ various programming options ▪ can be integrated into existing transponder systems such as MIFARE® Classic and Desfire as well as HITAG S/1 ▪ available as wirelessly networkable version with B-on-air 	

¹ only applies to the variant Corona I

² only applies to the variant Corona II

³ after consultation / may vary for air and sea freight delivery

Scope of Features

	Corona II	Corona I	125 kHz
Mode:			
Private Mode	•	•	•
Multi User Mode	•	•	•
Integrated functions:			
Battery warning	•	•	•
Block mode	-	•	•
Reset function	•	•	•
Logging	•	•	-
Optional functions:			
Automatic locking	•	•	•
Manual locking	•	•	•
Occupancy indicaton	•	•	•
Occupancy indicaton on several levels	•	•	•
LED locking indication	•	•	•
Signal tones	•	•	•
Functions adjustable via PC software:			
Automatic locking/ unlo-cking at a certain time	•	•	-
Time window usage	•	•	-
Locker numbers	•	•	-
Branch ID	•	•	-
Lock level	•	•	-
Clusure duration	•	-	-
Room information	•	-	-
Functions adjustable via management software:			
Check-in function	•	•	-
Check-out condition	•	•	-
Battery level	•	•	-

Dimensions

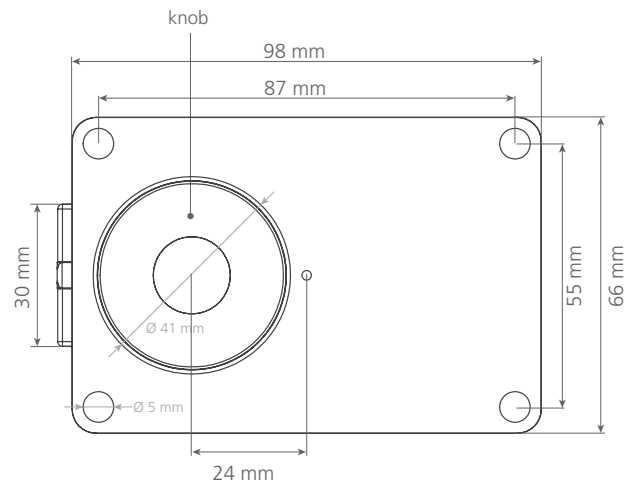

With bolt adjuster:

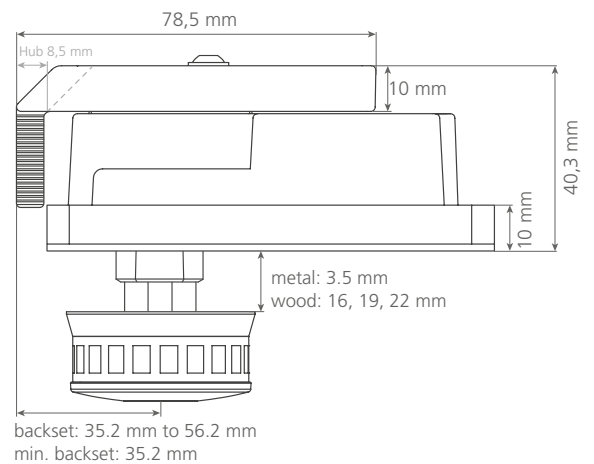

Without bolt adjuster:

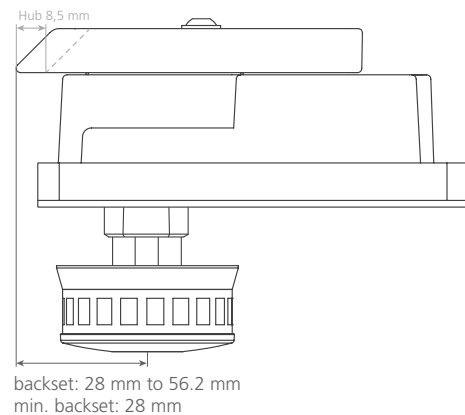

Mounting Hole Dimensions

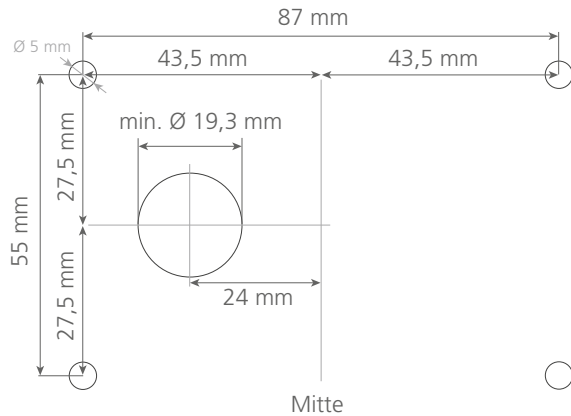

Functional Description

Mode: Fixed Assigned Authorization (Private Mode)

In this mode, a transponder medium is preset with which the lock can be operated. This mode is suitable for user groups where the user rights do not have to change permanently, e.g. in an office cabinet. The lock can be opened and closed with any stored transponder. Transponder media that are not stored are rejected by the lock.

Mode: Multi User Authorization (Multi User Mode)

This mode is suitable for constantly changing users who use the compartment temporarily or once, e.g. in a sports facility. Transponder media are valid for a single locking process and are deleted by the lock when it is opened again. The lock remains in the open state until it is locked again. Before locking, the door must be closed (slightly pressed). To lock the door, the user holds a transponder centrally in front of the lock.

Occupancy Identification

During the locking process, the transponder is provided with a occupancy identification. This identification prevents the transponder from locking further locks. The lock can only be opened again with the same transponder. The occupancy identification is cancelled again during the opening process.

Note: Occupied transponder media can also be released using the master card (point 5 under Configuration).

Master Card

The master card authorizes the configuration of the lock. The lock can be opened via the master card independently of the set mode (emergency opening). In addition the master card can terminate the block mode. In Multi User Mode, the transponder used for locking is deleted from the lock when it is opened by the master card.

Block Mode

After 100 consecutive failed attempts to open the lock, the lock blocks for 180 seconds. During this time, no action is possible on the lock. Presenting the master card cancels the block mode.

Battery warning

If the battery capacity falls below a certain limit, three consecutive descending beeps sound when a transponder is presented. If the critical range is reached, the lock can no longer be locked or can only be opened with the master card. With the Corona II variant, locking is possible despite low battery capacity. A low battery level is signaled by the flashing of the red LED. An individual time period can be set for the display via the LED. The battery warning via the LED then only occurs during this period.

Note: It is recommended to change the batteries after the first warning.

Automatic Locking (Private Mode)

The lock locks automatically after opening. Three locking times are possible:

Time 1	4 sec.
Time 2	8 sec.
Time 3	20 sec.

Note: To avoid damage to the lock, make sure that the door is closed so it can lock without any problems.

LED Locking Indication

The lock indicates the locked state by flashing the red LED every second.

Signal tones

Signal tones sound during the opening or locking process as well as when unauthorized transponders are presented.

Reset 1: Function Reset

All functions are reset to default settings. All settings previously made are deleted.

Reset 2: Transponder Reset

All assigned transponders are deleted from the lock.

Functional Description Corona I / Corona II**Logging**

The last 12 (Corona I) or 40 (Corona II) actions performed on the lock are logged and can be read out and displayed using a log card.

General Card¹

The general card is configured at the factory and transfers the master card IDs to the lock. Master cards can thus be assigned, deleted or overwritten with new master cards via the general card.

Functions adjustable via PC software:**Lock level**

The grouping of locks into different levels is used to authorize a transponder to operate several locks despite an active occupied identification. This is particularly suitable for locker room environments where both lockers and safe-deposit boxes are used. The transponder can then be used to operate one lock from each level.

Branch ID

A branch ID authorizes a transponder medium to operate a specific group of locks. Locks and transponders receive the same encrypted branch ID. If this does not match, the lock group cannot be operated with the transponder.

Automatic locking / unlocking at a certain time

The lock opens and locks automatically at individually definable times.

Locker Numbers (only Corona I)

When a lock is locked, the locker number is transferred to the transponder medium. This can then be read out via the BURG terminal, for example.

Usage Time Window

The lock can only be operated within the individually defined usage time window. Outside this period of time, the transponders are rejected (except for opening).

Closure Duration¹

The closure duration defines the maximum period (freely selectable from 2 hours) for which a lock may be closed from the time of locking. After the lock duration has expired, the lock opens automatically.

Room information¹

The transponder can be used to read off the locker number and location.

Functions adjustable via management software:**Check-In Function**

With the check-in function, the transponder medium receives authorization to use the lock. Without this authorization, the transponder cannot operate any lock. The authorization is assigned via a read/write device at the reception (during check-in). The device works with a future date, which is queried when the lock is operated. If the date is in the future, the transponder is accepted.

Note: It is recommended to consult with the management software provider before setting up this function to prevent problems during the writing process.

Battery Level



The current battery level is transferred to the transponder medium when the lock is operated. The battery level can then be read out via the transponder, e.g., during check-out.

¹ only applies to the variant Corona II
Corona | 05-2022

LED and Tone Signals for 125 kHz and Corona I

 Single, short flash

The lock starts the reading operation.

 Flashing for 5 seconds
 2 ascending beeps

The lock was successfully locked.

 Permanent flashing

The lock is locked.

 Flashing for 5 seconds



The lock was successfully unlocked.

 3 descending beeps



Batteries should be replaced as soon as possible

 Fast flashing while using a transponder

The lock is in block mode.

  Alternating flashing 10 times

There is a hardware problem. Repeat the opening/closing process several times. If the door is open, try pulling the latch (see page 2) outwards. If the problem persists, please contact the BURG service.

 Flashing 8 times
 4 beeps

The transponder is not accepted, which can have several reasons:

- The transponder has already locked another lock.
- The lock is already locked.
- The transponder was not checked-in correctly.
- The system IDs do not match.
- The lock is in battery replacement mode.
- The transponder was held too close to the lock or the distance to the lock was too long.

LED and Tone Signals for Corona II

 Permanent flashing



The lock is locked.

 Single, short flash
 2 descending beeps

The lock was successfully locked.

 Single, short flash
 2 descending beeps

The lock was successfully unlocked.

 Single, short flash
 2 descending beeps
 2 ascending beeps

The lock was successfully unlocked via Master Card.

 3 beeps

The transponder is not accepted (reasons for this are listed under 'LED and Tone Signals for 125 kHz and Corona I').

 4 beeps

The lock rejects the card type because it is not a user transponder.

 Short ticking for 4 seconds



The lock is in assigning / configuration mode.

 2 ascending beeps after configuration step

A function has been successfully set.

 3 descending beeps on unlocking/ locking



Battery warning.

  Double flash in open state

Battery warning.

  Double flash in closed state

Battery warning.

  Double flashing 7 times
 4 beeps

The lock is in battery change mode.

 4 beeps when changing batteries

A non-full battery has been inserted.

  Alternating flashing

There is a hardware problem.

Assembly Instructions

1 Drill mounting holes

Prepare the appropriate mounting hole on your furniture according to the installation drawing. The four frame holes must not be drilled completely through the material.

Tip: First drill the hole for the knob shaft, put the lock through it and mark the four holes for the screws through the holes on the lock.



2 Place back unit

Place the back unit on the back of the cabinet door by pushing the knob shaft from behind through the hole provided.



3 Fasten back unit

Fasten the back unit with the enclosed screws (Torx 20). It is recommended to tighten the screws diagonally one after the other.

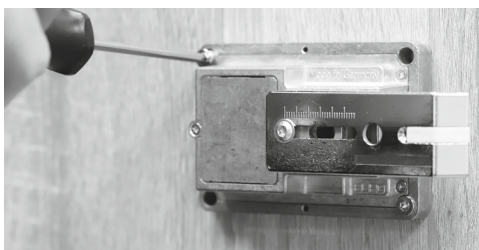

4 Place and tighten the knob

Place the knob on the knob shaft from the front. Hold it in place and tighten the knob from the rear (max. 3 Nm) using an Allen key (size 2.5). A torque wrench (e.g. Wera 7441) with variable torque adjustment can be used for this purpose.

Important: Make sure that the spring contacts in the knob are placed over the golden dots on the connector.

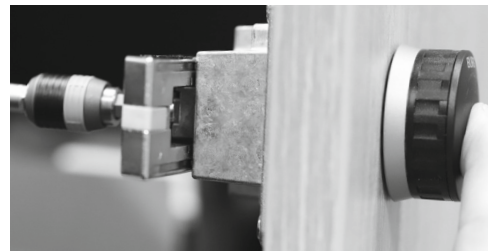

5 Adjust the latch

Loosen the bolt screw until the bolt can be moved. Turn the knob to the right as far as it will go and hold it firmly. Slide the bolt so that its bevel hits the strike plate or rebate (for metal lockers) when the door is closed. Now close the door so that the bolt can slide into the correctly adjusted position. Then open the door and tighten the bolt adjustment screw.

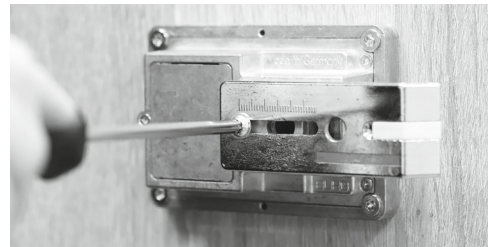

Find the assembly video here (wood):



Find the assembly video here (steel):



Configuration

1 Assign master card

a) Corona I (incl. 125 kHz)

1. Open battery compartment. Remove the outer battery.
2. Press the white button on the board below until you hear a ticking sound.
3. Hold the master card to be assigned within 5 seconds centrally in front of the knob during the ticking sound.
4. Two ascending beeps confirm the successful process.
5. Insert battery and close battery compartment.

Note: The white button must not be pressed with a metallic object.

b) Corona II

1. Hold the general card centrally in front of the knob.
2. Two ascending beeps confirm the successful process.

Note: The master card IDs are transferred to the general card at the factory.

2 Assign transponder (Private Mode)

1. Unlock the lock.
2. Hold the master card centrally in front of the knob until you hear a ticking sound.
3. Hold the transponder to be assigned centrally in front of the knob during the ticking sound.
4. Two ascending beeps confirm the successful process.

Note: After each assigned transponder, the ticking is extended by 5 seconds so that further transponders can be assigned.

3 Delete transponder (Private Mode)

1. Unlock the lock.
2. Hold the master card centrally in front of the knob until you hear a ticking sound.
3. Hold the transponder to be deleted centrally in front of the knob during the ticking sound.
4. Two ascending beeps confirm the successful process.

Note: The function card Transponder Reset can be used to delete all transponders.

4 Activate and deactivate functions

1. Unlock the lock.
2. Hold the master card centrally in front of the knob until you hear a ticking sound.
3. Hold the function card centrally in front of the knob during the ticking sound.
4. Two ascending beeps confirm the successful process.

Note: Deactivation occurs in the same way.

Function cards:

- Multi User Mode
- Private Mode
- Signal tones
- LED locking indication
- Automatic locking
- Function reset (reset 1)
- Transponder reset (reset 2)

5 Release occupancy transponder¹

1. Unlock the lock.
2. Hold the master card centrally in front of the knob until you hear a ticking sound.
3. Hold the master card centrally in front of the knob again until you hear two ascending beeps.
4. After the ticking sound, hold the transponder to be released within 10 seconds centrally in front of the knob.
5. Two ascending beeps confirm the successful process.

Operation

1 Lock

1. Close the door (slightly pressed). Hold the transponder centrally in front of the knob for 3 seconds.
2. The flashing of the red LED and the signal tones (when activated) confirm the successful process.

Note: When automatic locking is activated, the lock locks automatically after a few seconds after opening.

2 Unlock

1. Hold the transponder centrally in front of the knob.
2. The flashing of the green LED and the signal tones (when activated) confirm the successful process.
3. Turn the knob and pull the door.

Reset to Default Settings

1 Reset 1: Function Reset

1. Unlock the lock.
2. Hold the master card centrally in front of the knob until you hear a ticking sound.
3. Hold the function card *Function Reset* centrally in front of the knob during the ticking sound.
4. Two ascending beeps confirm the successful process.

2 Reset 2: Transponder Reset

1. Unlock the lock.
2. Hold the master card centrally in front of the knob until you hear a ticking sound.
3. Hold the function card *Transponder Reset* centrally in front of the knob during the ticking sound.
4. Two ascending beeps confirm the successful process.

Battery Replacement

- 1 Open the screw (Torx 8) of the battery compartment cover of the back unit.
- 2 Open the battery compartment cover and remove the batteries according to the lock type.
Corona I: Remove both batteries simultaneously and replace them within 10 seconds.
Corona II: Remove both batteries one after the other.
- 3 Insert new batteries according to the +/- symbols.
- 4 Insert the battery compartment cover and close it with the screw on the back of the back unit.

Note: Depending on the position of the latch, it must be adjusted in order to open the battery compartment. It is recommended to mark the latch position before adjusting it so that the latch can be reset to the correct position after the change.

Disposal and Battery Note

EU Directive 2012/19/EU regulates the proper take-back, treatment and recycling of used electronic equipment. Every consumer is required by law to dispose of batteries, accumulators or electrical and electronic equipment („waste equipment“) powered by batteries or accumulators separately from household waste, as they contain harmful substances and valuable resources. Disposal can be done at a collection or take-back point approved for this purpose, e.g. a local recycling center. Waste equipment, batteries or rechargeable batteries are accepted there free of charge and recycled in an environmentally friendly and resource-saving manner. Waste equipment, used batteries or rechargeable batteries can also be returned to us. The return must be sufficiently stamped to the address below.

The following symbol on the waste electrical equipment, batteries or accumulators indicates that they must not be disposed of with household waste:



Caution when using batteries!

The battery may explode or release flammable gases if it is mishandled, destroyed, or the wrong type of battery is used. Do not recharge the battery, disassemble it, expose it to extremely high temperatures or throw it into a fire.

On batteries containing harmful substances, you will find indications in the form of abbreviations for the ingredients cadmium (Cd), mercury (Hg) and lead (Pb) in each case.

BURG F. W. Lüling KG

Volmarsteiner Str. 52
58089 Hagen (Germany)
Fon +49(0)23 35.63 08-0
info@burg.de
www.burg.de